

viscount®

R64

diagramma
schematic diagram

schaltplan
schéma technique

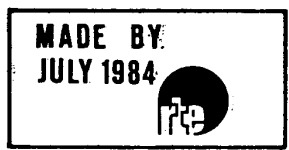

COD.803080

SHEET
1

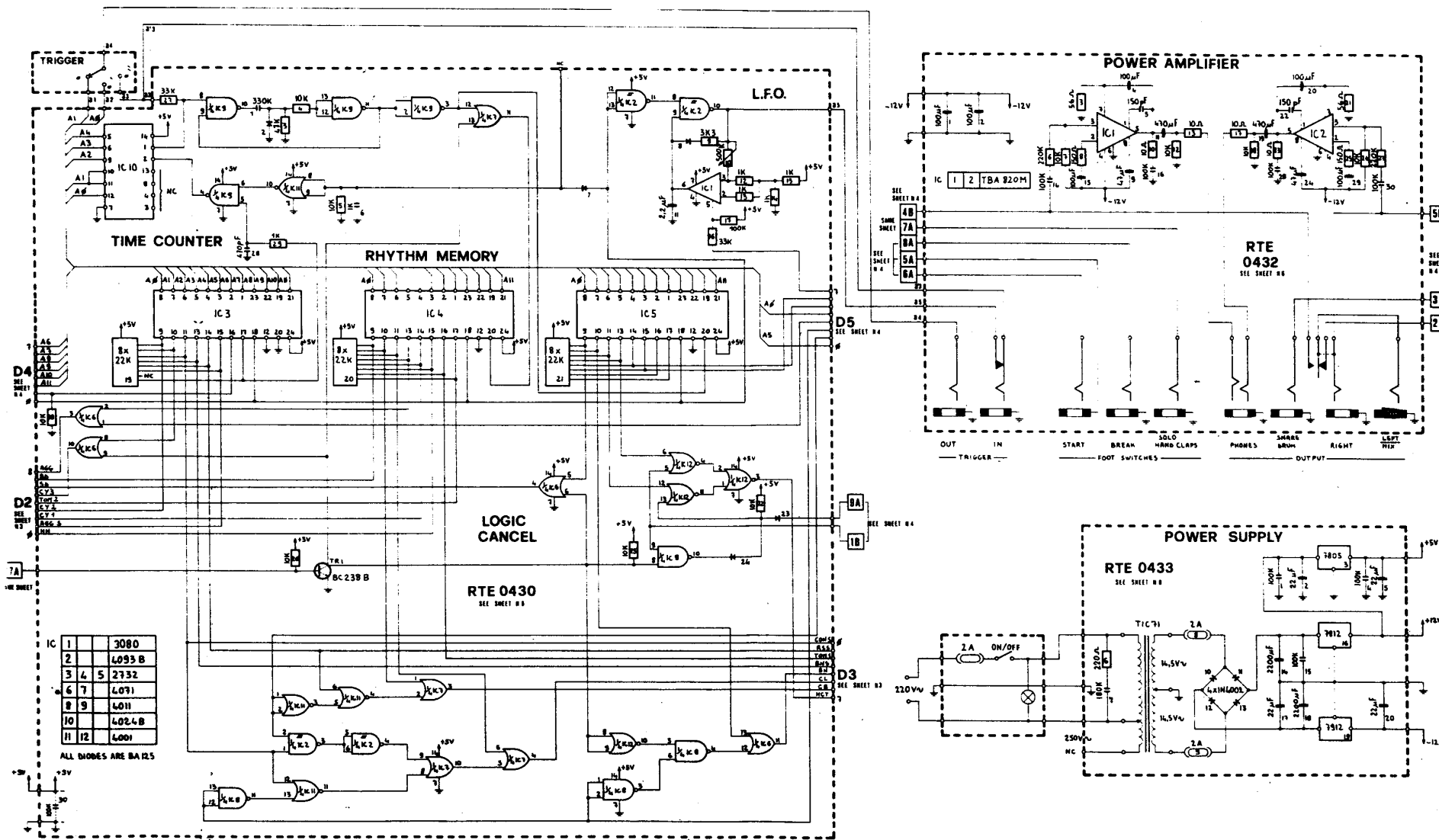

RTE
0421
SEE SHEET 11
P.C.M. BOARD
A

E2
SAME SHEET
9

E1
SAME SHEET

RTE
0422
SEE SHEET 11
CYMBAL NOISE
GENERATOR
B

D9
SAME SHEET
9

E3
SAME SHEET

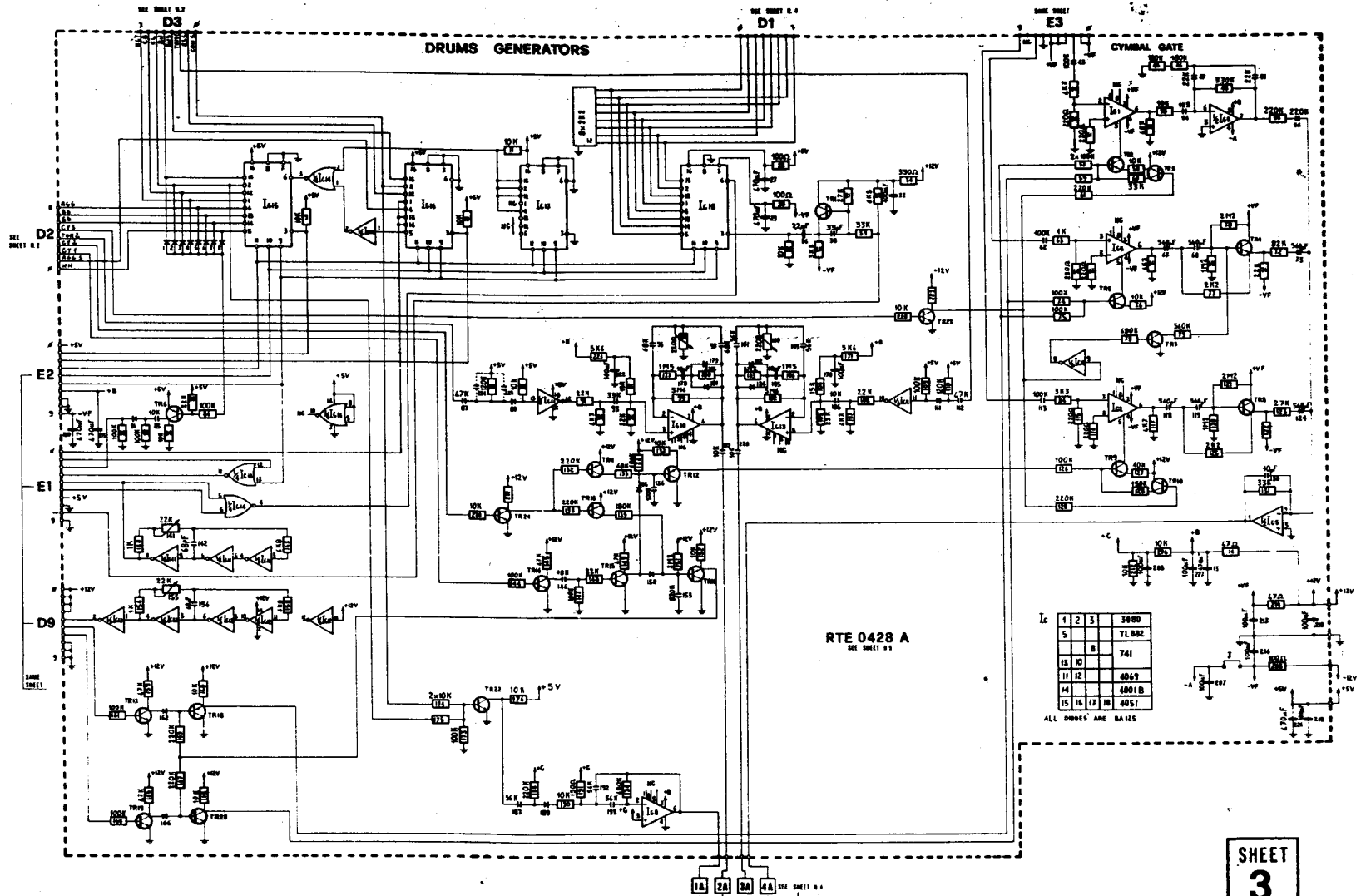

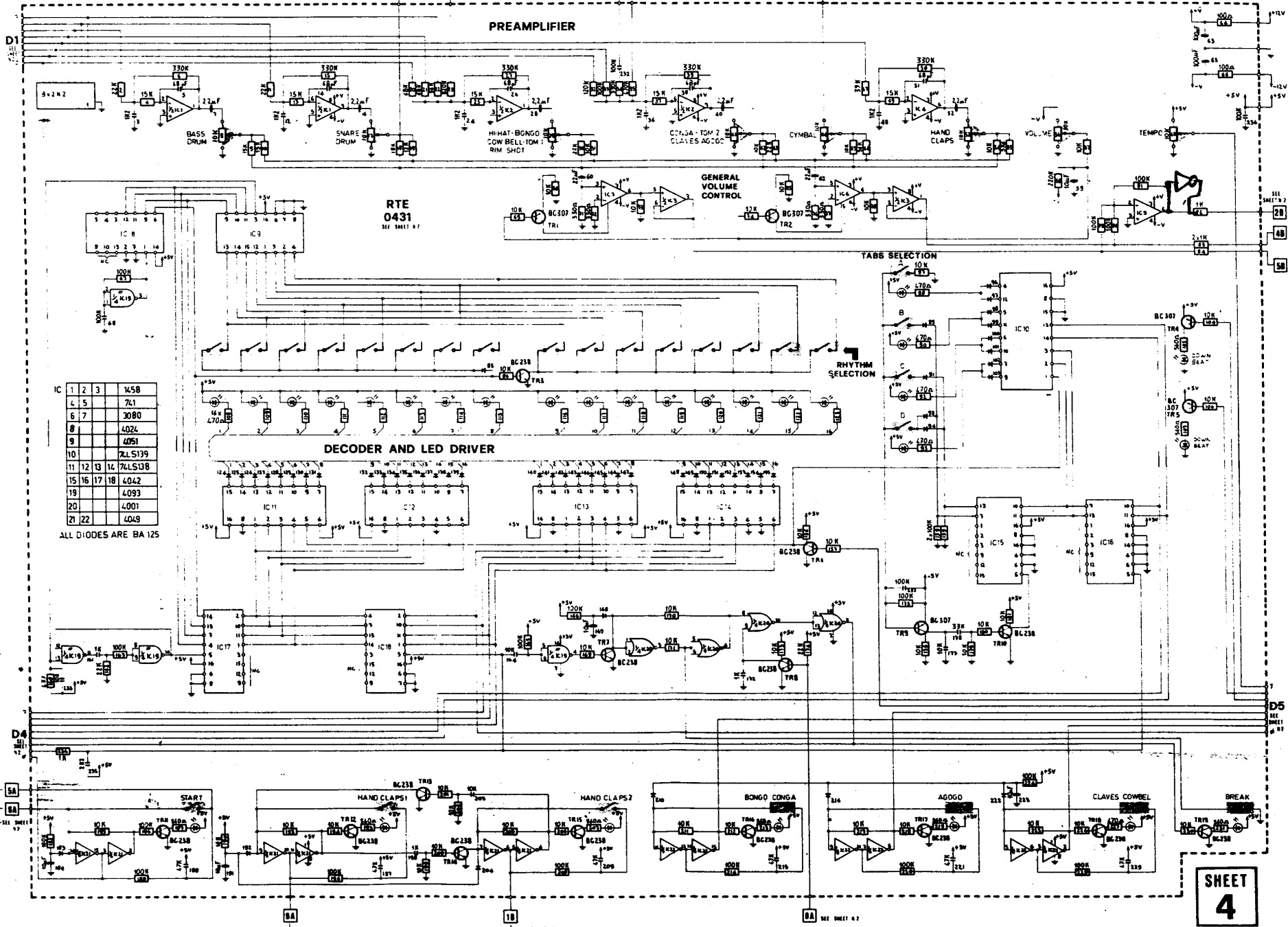

IC

1	2	3	74S8
4	5		741
6	7		3080
8			4024
9			4051
10			74LS139
11	12	13	74LS138
15	16	17	4042
19			4093
20			4001
21	22		4049

ALL DIODES ARE BA 125

PREAMPLIFIER

RTE 0431

DECODER AND LED DRIVER

TABS SELECTION

RHYTHM SELECTION

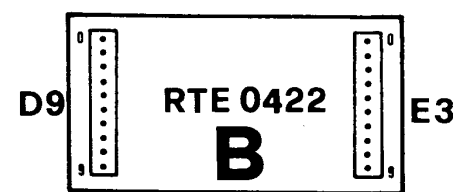
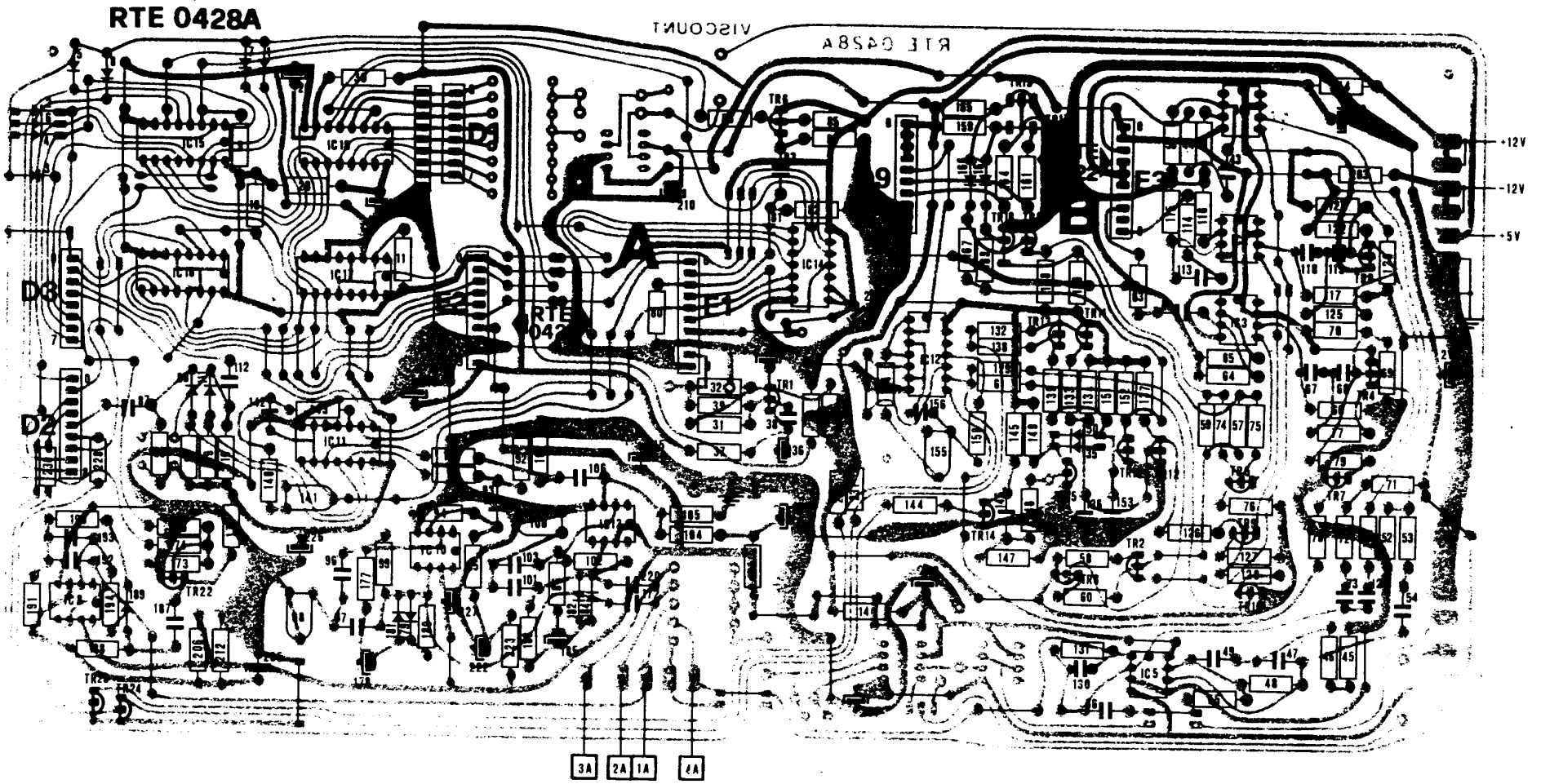

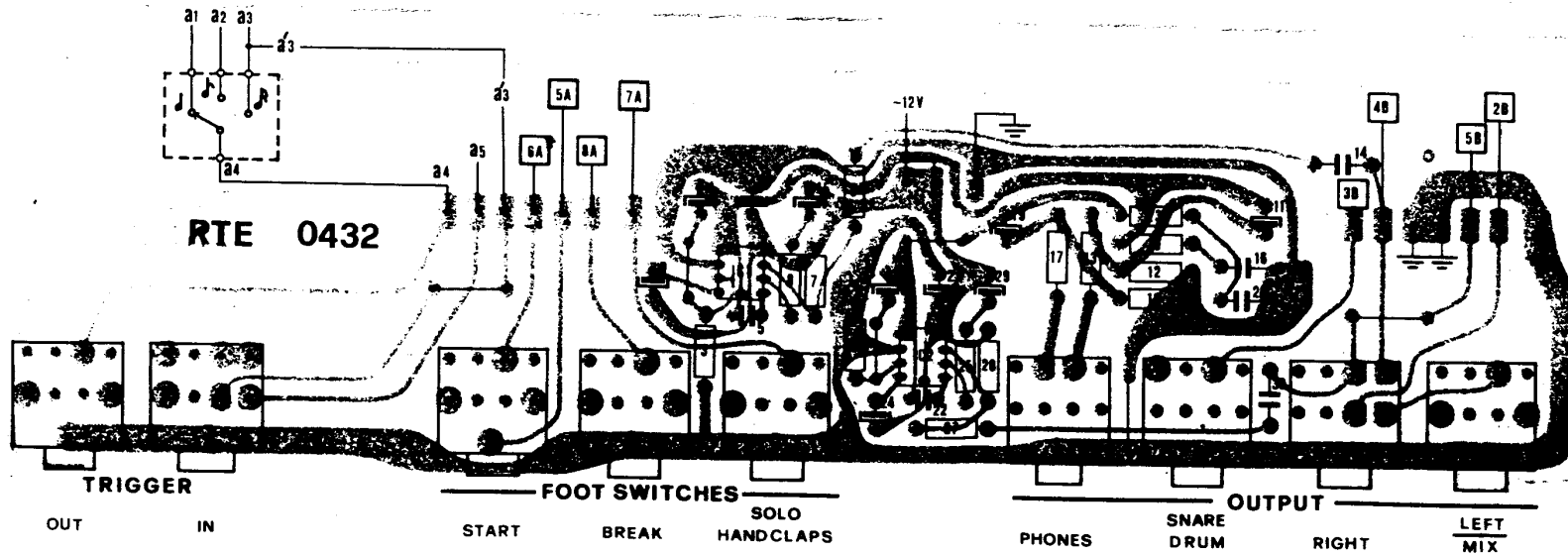
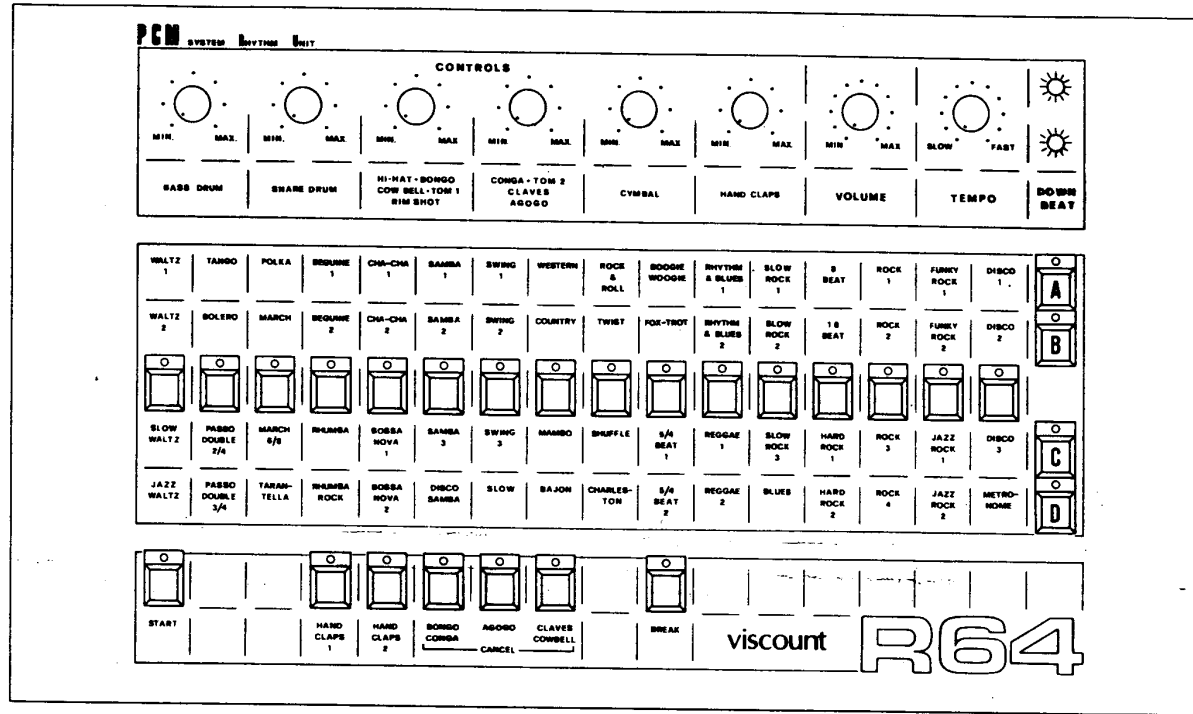

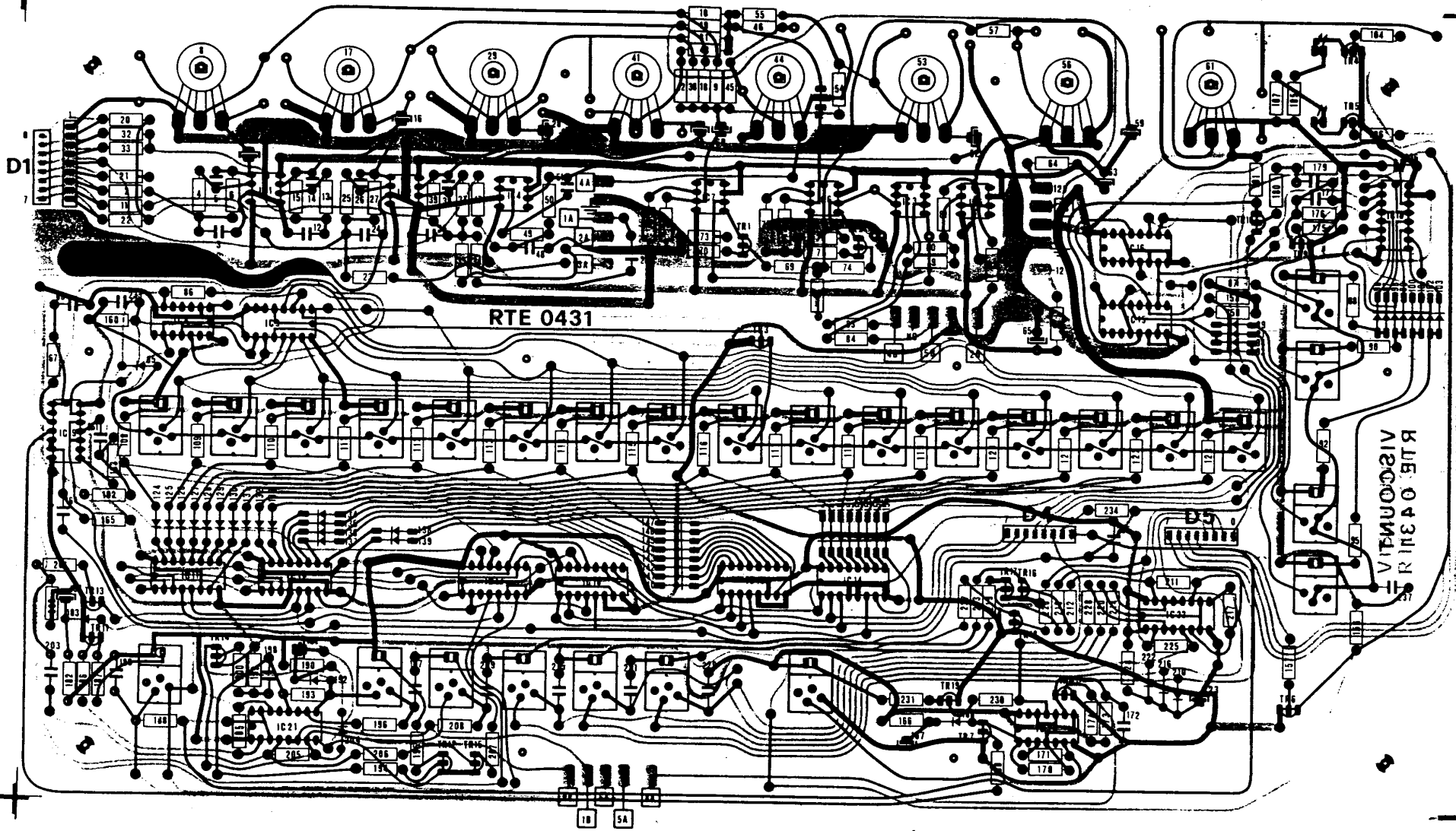

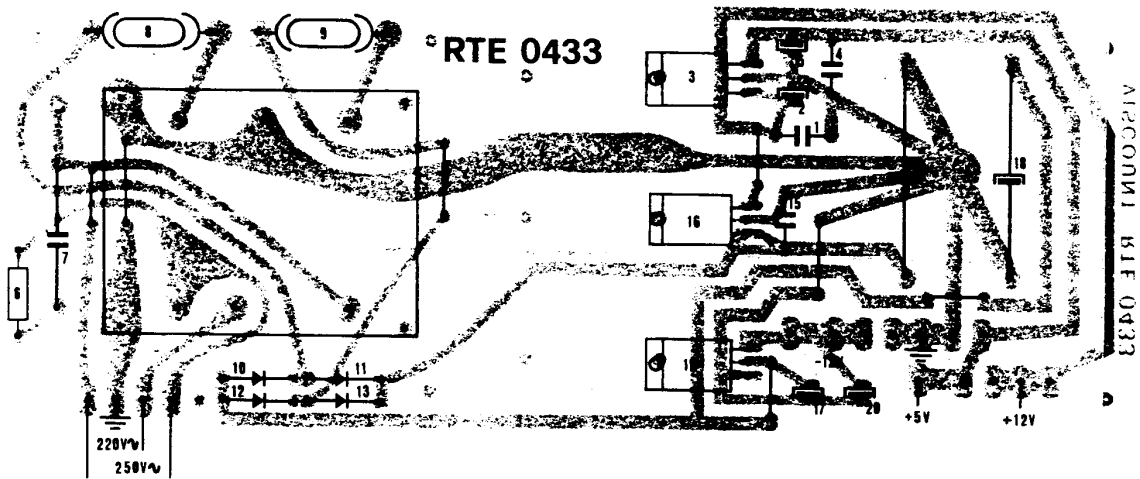
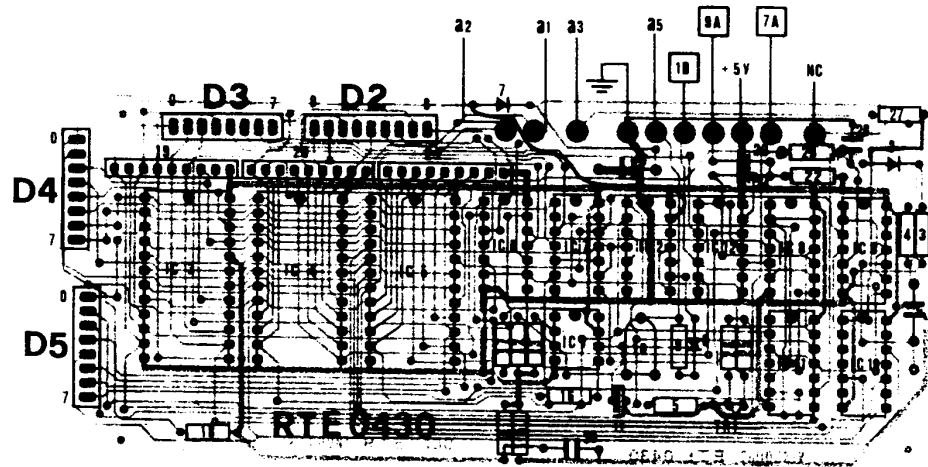

SHEET
8

VISCONTI ORGANS
made by:



INTERCONTINENTAL ELECTRONICS S.p.A.
P.O. Box 5
47040 MONDAINO (FO) - ITALY
Tel. (0541) 981700
Telex 550205 Inter